

# Glidlister

## T-PROFIL Simplex

Best.nr.	Delning	ISO-nr	B	A	b	a		Vikt/m
T 13810	3/8" x 7/32"	06B-1	15	10	5,4	1,5		0,130
T 11210 T 11215 T 11220	1/2" x 5/16"	08B-1	20	10 15 20	7,4	2,2		0,165 0,260 0,350
T 15810 T 15815 T 15820	5/8" x 3/8"	10B-1	20	10 15 20	9,2	2,6		0,160 0,260 0,350
T 13410 T 13415 T 13420	3/4" x 7/16"	12B-1	25	10 15 20	11,3	2,4		0,210 0,325 0,440
T 1115 T 1120 T 1130	1" x 17 mm	16B-1	40	15 20 30				0,470 0,660 1,040
T 11415 T 11420	1 1/4" x 3/4"	20B-1	45	15 20	19,0	4,3		0,530 0,730
T 111215 T 111220	1 1/2" x 1"	24B-1	60	15 20	24,6	5,6		0,665 0,865
T 13420	1 3/4" x 31 mm	28B-1	75	20	30,0	6,9		1,130
T 1220	2" x 31 mm	32B-1	80	20	30,0	7,8		1,150

**Material:** Polyeten PEHD  
**Standardfärg:** Grön  
**Standardlängd:** 2 m

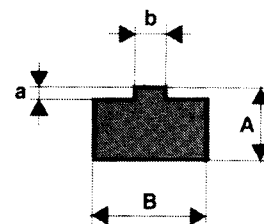

## T-PROFIL Duplex

Best.nr.	Delning	ISO-nr	B	A	b	a	c	Vikt/m
T 23810	3/8" x 7/32"	06B-2	25	10	5,4	1,5	15,74	0,250
T 21210 T 21215 T 21220	1/2" x 5/16"	08B-2	35	10 15 20	7,4	2,2	21,42	0,360 0,530 0,690
T 25810 T 25815 T 25820	5/8" x 3/8"	10B-2	40	10 15 20	9,2	2,6	25,79	0,425 0,600 0,770
T 23415 T 23420	3/4" x 7/16"	12B-2	45	15 20	11,3	2,4	30,76	0,480 0,680
T 2115 T 2120	1" x 17 mm	16B-2	65	15 20	16,5	3,5	48,38	0,820 1,020
T 211415 T 211420	1 1/4" x 3/4"	20B-2	70	15 20	19,0	4,3	54,45	0,930 1,170
T 211220	1 1/2" x 1"	24B-2	88	20	24,6	5,6	72,96	1,620
T 213425	1 3/4" x 31 mm	28B-2	105	25	30,0	6,9	89,56	2,490
T 2220	2" x 31 mm	32B-2	105	30	30,0	7,8	88,55	2,930

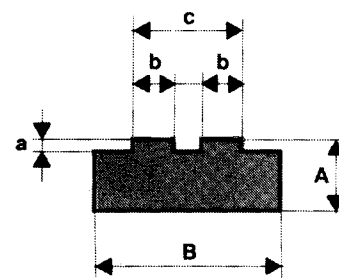

# Glidlister

## T-PROFIL Triplex

Best.nr.	Delning	ISO-nr	B	A	b	a	c	Vikt/m
T 33810	3/8" x 7/32"	06B-3	35	10	5,4	1,5	25,88	0,306
T 31210 T 31215 T 31220	1/2" x 5/16"	08B-3	45	10 15 20	7,4	2,2	35,24	0,381 0,595 0,808
T 35810 T 35815 T 35820	5/8" x 3/8"	10B-3	55	10 15 20	9,2	2,5	42,38	0,455 0,680 0,910
T 33415 T 33420	3/4" x 7/16"	12B-3	60	15 20	11,3	2,4	50,22	0,546
T 3120	1" x 17 mm	16B-3	95	20	16,5	3,5	80,26	1,167

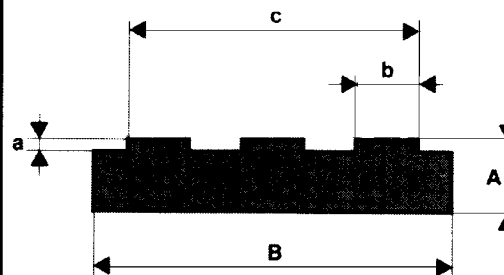

## C-STÅL

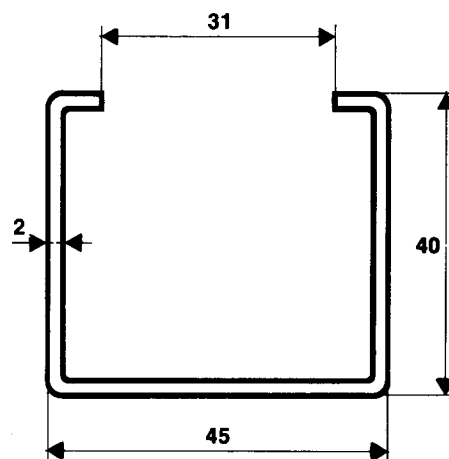
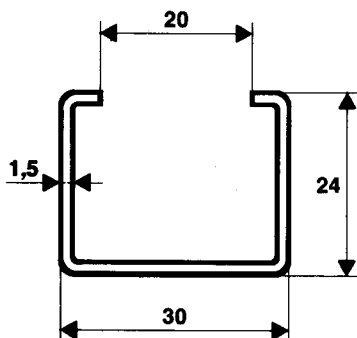
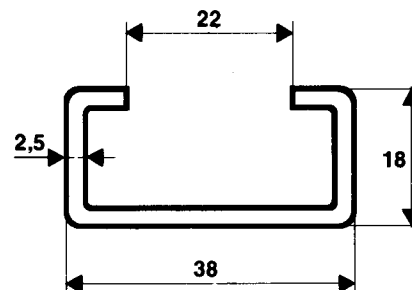
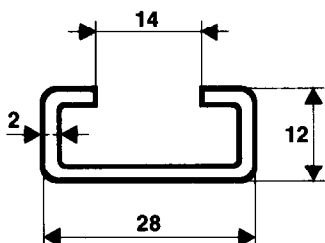
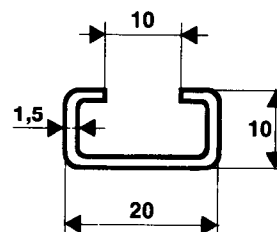
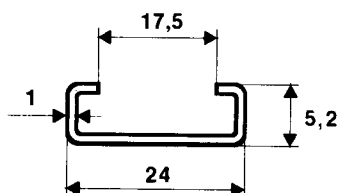

Material: Förzinkat eller rostfritt

Standardlängd: 2 m. Även 6 m kan levereras

Reservation för måttförändringar



# Glidlister

## BL-PROFIL Kasset

Best.nr	Delning	ISO-nr.	B	A	a1	a2	a3	D1	D	d2	Vikt/m
BL 38	3/8" x 7/32"	06B-1	20	25	5,6	8,7	10,0	6,6	9,3	4,0	0,414
BL 12	1/2" x 5/16"	08B-1	24	30	7,6	11,5	13,5	8,7	12,8	5,0	0,564
BL 58	5/8" x 3/8"	10B-1	30	35	9,5	13,5	14,8	10,4	15,4	6,0	0,832
BL 34	3/4" x 7/16"	12B-1	40	35	11,5	15,9	17,5	12,3	16,9	7,0	1,106
BL 1	1" x 17 mm	16B-1	40	45	16,9	25,7	26,8	16,1	24,4	9,0	1,231
BL 114	1 1/4" x 3/4"	20B-1	50	50	19,4	29,3	31,2	19,3	27,5	11,0	1,726
BL 112	1 1/2" x 1"	24B-1	60	60	25,2	38,2	40,1	25,7	36,5	16,0	2,332
BL 134	1 3/4" x 31 mm	28B-1	60	70	30,8	46,9	48,9	28,3	41,5	17,0	2,473
BL 2	2" x 31 mm	32B-1	70	75	30,8	47,3	53,0	29,6	44,5	19,0	3,264

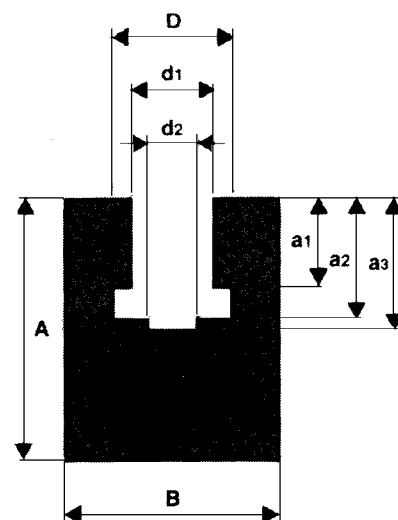

## C-10 PROFIL med C-stål (förz.)

Best.nr	Delning	ISO-nr.	Ac	B	b	a					Vikt/m
C 38	3/8" x 7/32"	06B-1	24	30	6,6	5,6					1,280
C 12	1/2" x 5/16"	08B-1	24	30	8,7	7,6					1,280
C 58	5/8" x 3/8"	10B-1	24	30	10,4	9,5					1,280
C 34	3/4" x 7/16"	12B-1	24	30	12,3	11,5					1,280
C 1	1" x 17 mm	16B-1	40	45	16,1	16,9					3,200

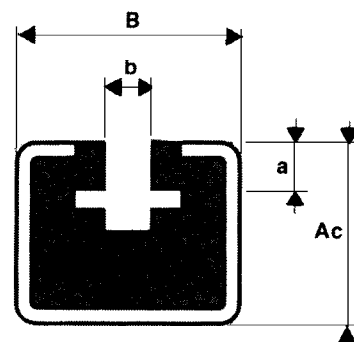

## COMBI-PROFIL med C-stål (förz.)

Best.nr	Delning	ISO-nr.	Prof.	A	B	A1	A2	Ac	b		Vikt/m
Comb 38	3/8" x 7/32"	06B-1	C 3	26,4	20	31,6	19,5	28,4	14,5		0,900
Comb 12	1/2" x 5/16"	08B-1	C 3	28,0	20	34,8	18,9	30,5	16,5		0,960
Comb 58	5/8" x 3/8"	10B-1	C 3	34,4	20	41,1	21,2	36,0	15,5		1,120
Comb 34	3/4" x 7/16"	12B-1	C 5	38,5	28	47,5	24,8	41,5	18,5		1,700
Comb 1	1" x 17 mm	16B-1	C 9	52,4	38	69,4	45,1	61,4	25,0		3,100

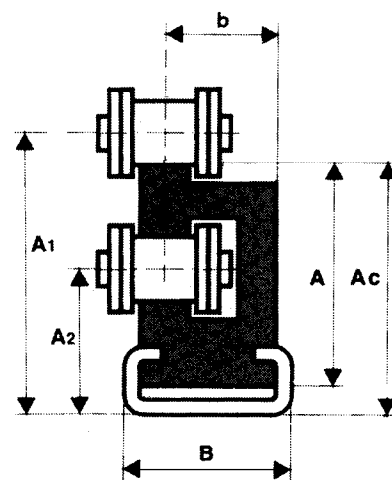

## Glidlister

### CP-PROFIL Plan med C-stål (förz.)

Best. nr	B	A	a	Ac	Vikt/m
C3 A 10	20	10	4	14	0,610
C3 A 15	20	15	7	17	0,700
C3 A 20	20	20	12	22	0,800
C5 A 10	28	10	3	15	1,216
C5 A 15	28	15	6	18	1,349
C5 A 20	28	20	12	24	1,530
C9 A 10	38	10	3	21	1,295
C9 A 15	38	15	6	24	1,585
C9 A 20	38	20	12	30	1,720

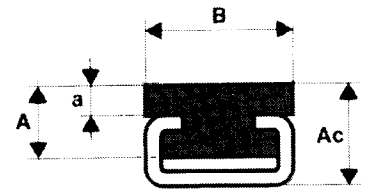

### CT-PROFIL Simplex med C-stål (förz.)

Best.nr.	Delning	ISO-nr	B	A	a	b	Ac	Vikt/m
CT 138	3/8" x 7/32"	06B-1	20	15	1,5	5,4	17	0,300
CT 112	1/2" x 5/16"	08B-1	20	15	2,2	7,4	17	0,400
CT 158	5/8" x 3/8"	10B-1	20	15	2,6	9,2	17	0,565
CT 134	3/4" x 7/16"	12B-1	20	15	2,4	11,3	17	0,605
CT 11	1" x 17 mm	16B-1	28	15	3,5	16,5	18	1,247
CT 1114	1 1/4" x 3/4"	20B-1	38	20	4,3	19,0	24	1,295

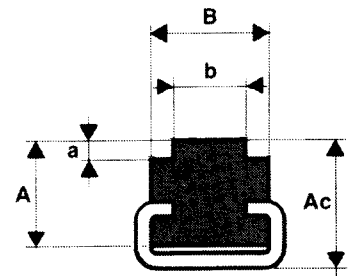

### E-PROFIL Simplex

Best.nr	Delning	ISO-nr.	B	A	a	a1	b	b1	Vikt/m
E 38	3/8" x 7/32"	06B-1	25	10	1,5	4,35	5,4	15	0,260
E 12	1/2" x 5/16"	08B-1	30	15	2,2	7,17	7,4	20	0,310
E 58	5/8" x 3/8"	10B-1	33	20	2,6	9,45	9,2	23	0,360
E 34	3/4" x 7/16"	12B-1	38	20	2,4	11,11	11,3	28	0,400
E 1	1" x 17 mm	16B-1	51	25	3,5	16,48	16,5	41	0,600

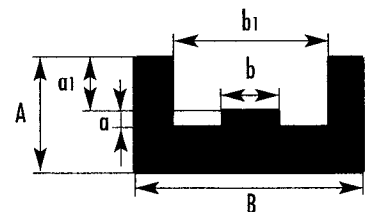

Finns även för duplex kedja.